

## CER7032C

AEC-Q200



### ■ Features

- High reliability available for automotive application.
- SMD magnetic shielded type of power inductor.
- Suitable for power supply choke coil.
- AEC-Q200 compliant
- Operating temperature : -40°C~+150°C(The self-heating is included)

Magnetic structure :



Weight : 0.51 g

### ■ Applications

- Automotive/ECU, LED Headlights, Car Audio, Car Navigation
- Others/Medical, Energy, Power Supply, FA

### ■ Dimensions

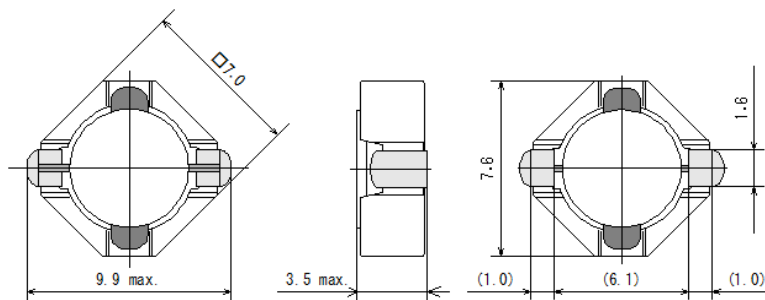

(Unit : mm)

### ■ Recommended Land Pattern

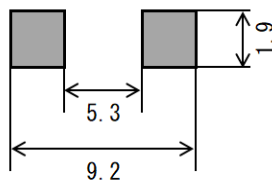

(Unit : mm)



SAGAMI ELEC CO., LTD.  
<https://www.sagami-elec.co.jp>

10-30, Ichibashimo-cho, Tsurumi-ku, Yokohama, Kanagawa 230-0024, Japan  
Over Seas Sales Dept. TEL : +81 45 511 3141, E-mail : ossg@sagami-elec.co.jp  
Engineering Dept. TEL : +81 45 521 4543

The contents of this catalogue are subject to change without notice.

## ■ Specifications

SAGAMI Part No.	Inductance ( $\mu$ H)	DCR ( $\Omega$ ) $\pm 30\%$	DC Saturation Allowable Current (A)		Temperature Rise Allowable Current (A)	
			Typical	Spec	Typical	Spec
CER7032C-1R2N	1.2 $\pm 30\%$	0.0080	6.85	5.20	6.40	4.60
CER7032C-1R6N	1.6 $\pm 30\%$	0.0100	5.80	4.50	5.90	4.30
CER7032C-2R2N	2.2 $\pm 30\%$	0.0130	5.20	4.10	5.20	3.90
CER7032C-2R7N	2.7 $\pm 30\%$	0.0160	4.45	3.65	4.50	3.35
CER7032C-3R3N	3.3 $\pm 30\%$	0.0190	3.95	3.10	4.25	3.00
CER7032C-4R3N	4.3 $\pm 30\%$	0.0210	3.65	2.75	3.90	2.85
CER7032C-5R1N	5.1 $\pm 30\%$	0.0270	3.35	2.60	3.50	2.50
CER7032C-6R2N	6.2 $\pm 30\%$	0.0330	3.05	2.35	3.20	2.20
CER7032C-6R8N	6.8 $\pm 30\%$	0.0360	2.80	2.20	3.10	2.10
CER7032C-8R2N	8.2 $\pm 30\%$	0.0430	2.60	2.00	2.65	1.90
CER7032C-9R1N	9.1 $\pm 30\%$	0.0470	2.55	1.95	2.55	1.85
CER7032C-100M	10 $\pm 20\%$	0.0500	2.30	1.75	2.50	1.75
CER7032C-120M	12 $\pm 20\%$	0.0560	2.20	1.65	2.30	1.65
CER7032C-150M	15 $\pm 20\%$	0.0720	1.85	1.45	2.05	1.50
CER7032C-180M	18 $\pm 20\%$	0.0930	1.70	1.30	1.85	1.35
CER7032C-220M	22 $\pm 20\%$	0.110	1.55	1.20	1.60	1.20
CER7032C-270M	27 $\pm 20\%$	0.130	1.45	1.10	1.50	1.10
CER7032C-330M	33 $\pm 20\%$	0.150	1.25	1.00	1.40	1.00
CER7032C-390M	39 $\pm 20\%$	0.190	1.15	0.900	1.20	0.900
CER7032C-470M	47 $\pm 20\%$	0.230	1.05	0.850	1.10	0.800
CER7032C-560M	56 $\pm 20\%$	0.270	1.00	0.750	1.05	0.750
CER7032C-680M	68 $\pm 20\%$	0.310	0.910	0.700	0.960	0.700
CER7032C-820M	82 $\pm 20\%$	0.380	0.890	0.650	0.840	0.600
CER7032C-101M	100 $\pm 20\%$	0.460	0.760	0.600	0.740	0.550
CER7032C-121M	120 $\pm 20\%$	0.570	0.670	0.500	0.700	0.480
CER7032C-151M	150 $\pm 20\%$	0.720	0.620	0.470	0.630	0.440
CER7032C-181M	180 $\pm 20\%$	0.810	0.540	0.430	0.560	0.400
CER7032C-221M	220 $\pm 20\%$	1.06	0.490	0.390	0.500	0.360
CER7032C-271M	270 $\pm 20\%$	1.33	0.450	0.350	0.440	0.330
CER7032C-331M	330 $\pm 20\%$	1.53	0.410	0.310	0.400	0.300
CER7032C-391M	390 $\pm 20\%$	1.91	0.380	0.290	0.380	0.270
CER7032C-471M	470 $\pm 20\%$	2.14	0.340	0.260	0.360	0.250
CER7032C-561M	560 $\pm 20\%$	2.80	0.310	0.240	0.290	0.230
CER7032C-681M	680 $\pm 20\%$	3.20	0.280	0.230	0.280	0.210
CER7032C-821M	820 $\pm 20\%$	4.19	0.260	0.200	0.240	0.180
CER7032C-102M	1000 $\pm 20\%$	4.67	0.230	0.170	0.220	0.170

Inductance Measuring Condition:100kHz,1V

DC saturation allowable current:The current value which inductance decrease within 30% from the initial value

Temperature rise allowable current:The rise in temperature of core surface is within 40°C



SAGAMI ELEC CO., LTD.  
<https://www.sagami-elec.co.jp>

10-30, Ichibashimo-cho, Tsurumi-ku, Yokohama, Kanagawa 230-0024, Japan  
 Over Seas Sales Dept. TEL : +81 45 511 3141, E-mail : ossg@sagami-elec.co.jp  
 Engineering Dept. TEL : +81 45 521 4543

The contents of this catalogue are subject to change without notice.

# DC bias characteristics vs Temperature Rise Graph

■ L(25°C)      ■  $\Delta T$

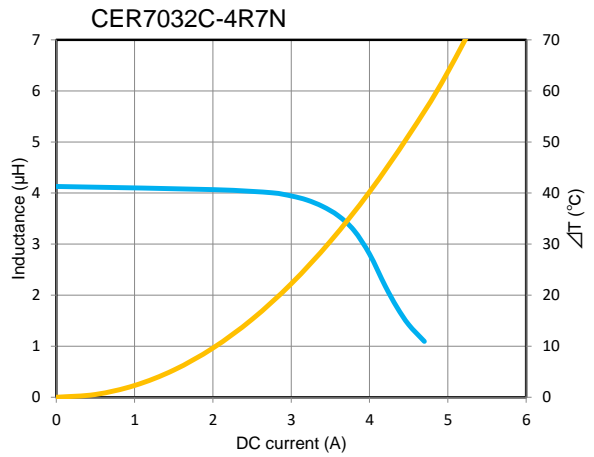
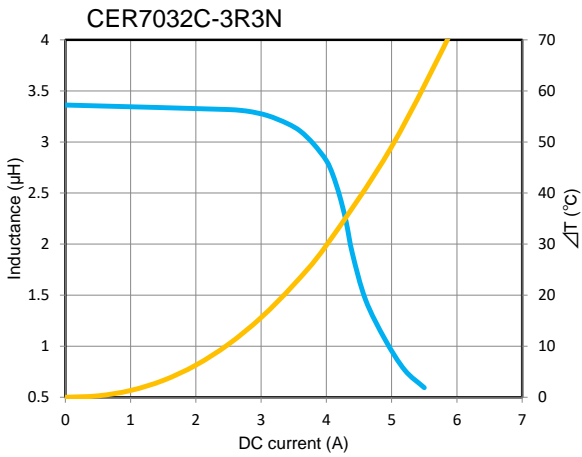
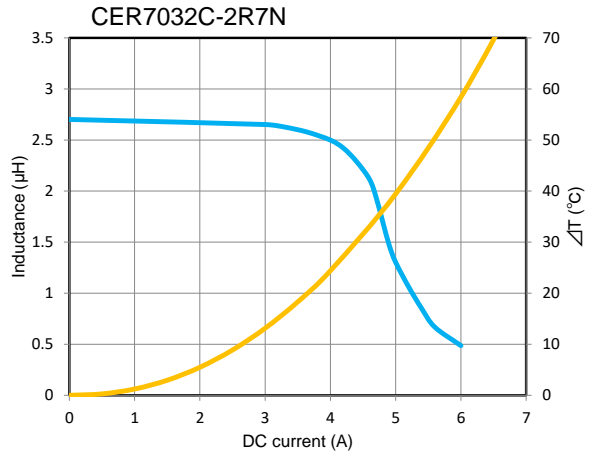
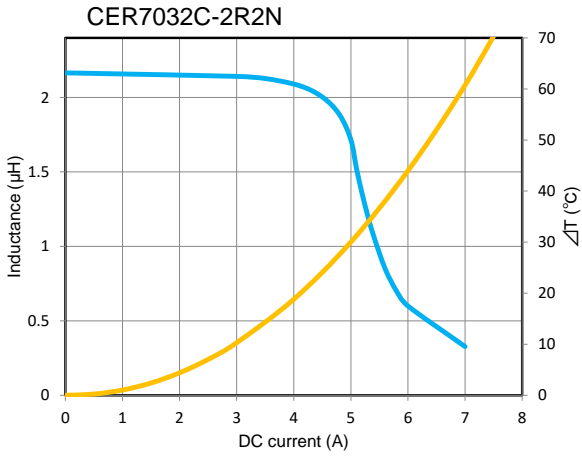
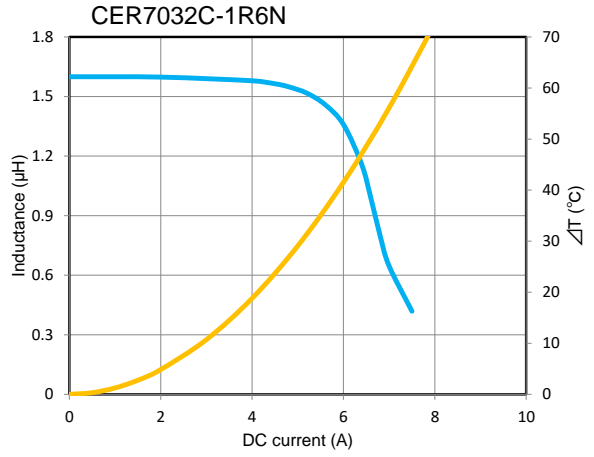
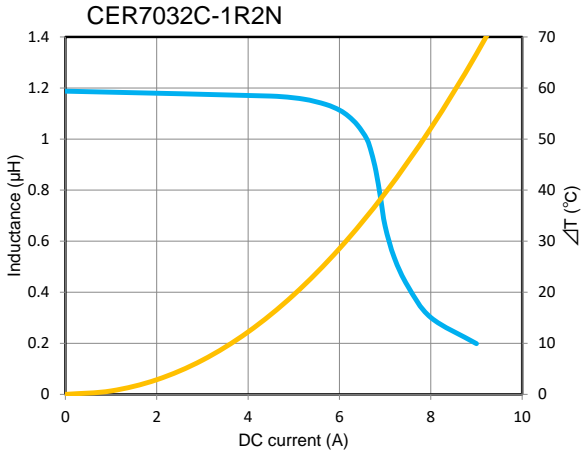

# DC bias characteristics vs Temperature Rise Graph

 L(25°C)

  $\Delta T$

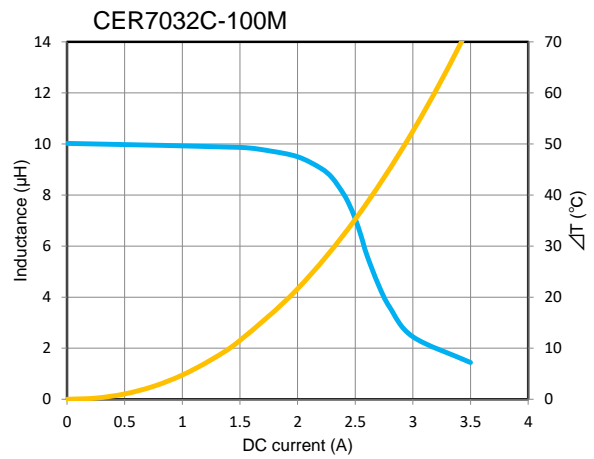
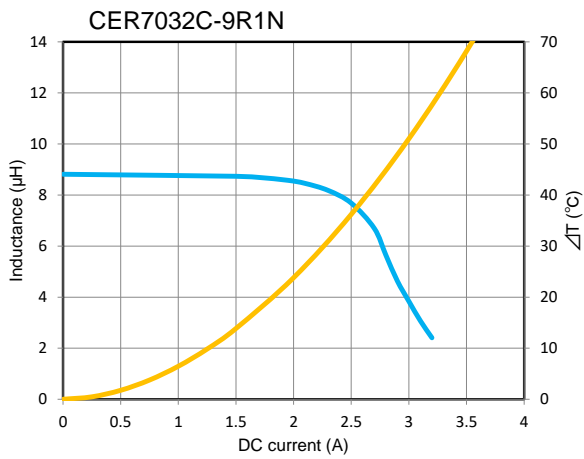
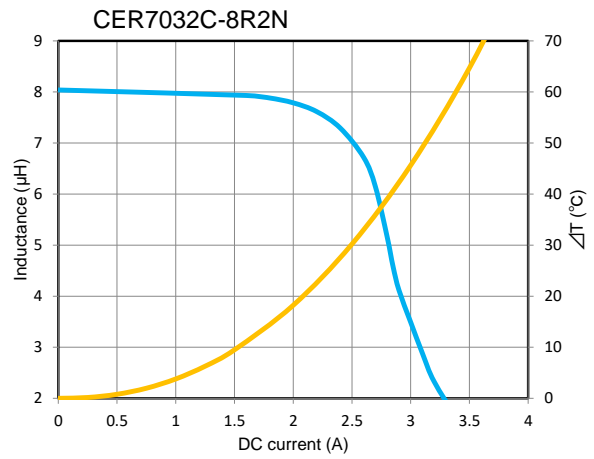
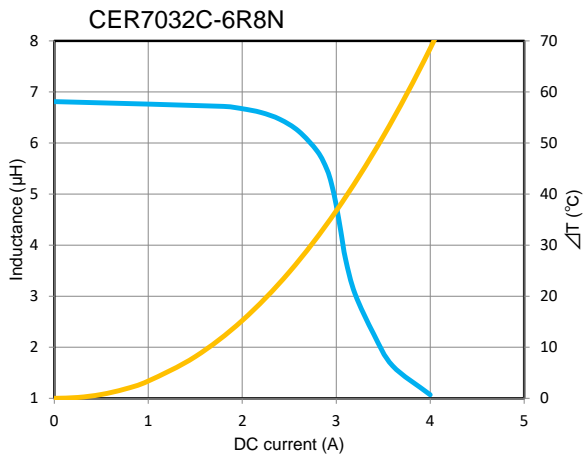
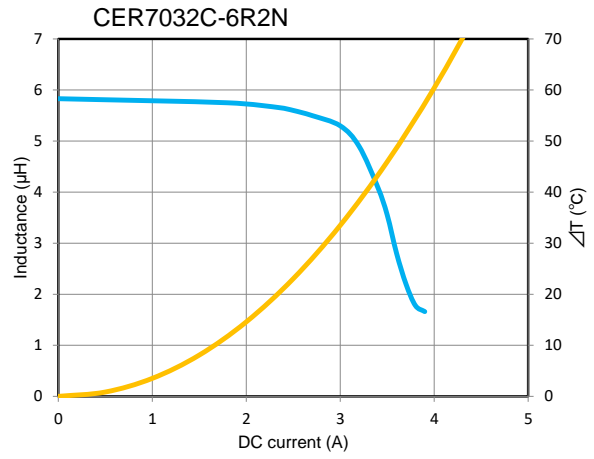
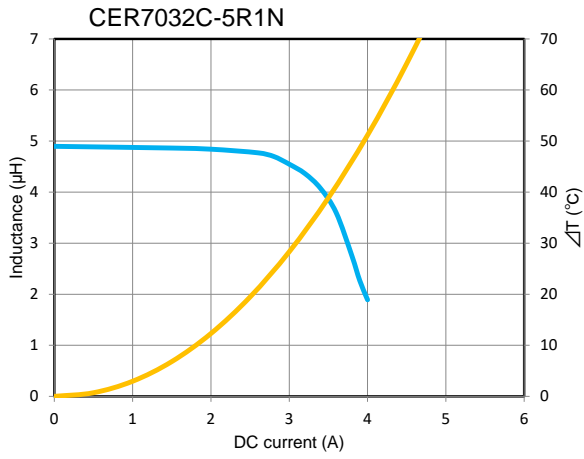

# DC bias characteristics vs Temperature Rise Graph

 L(25°C)

  $\Delta T$

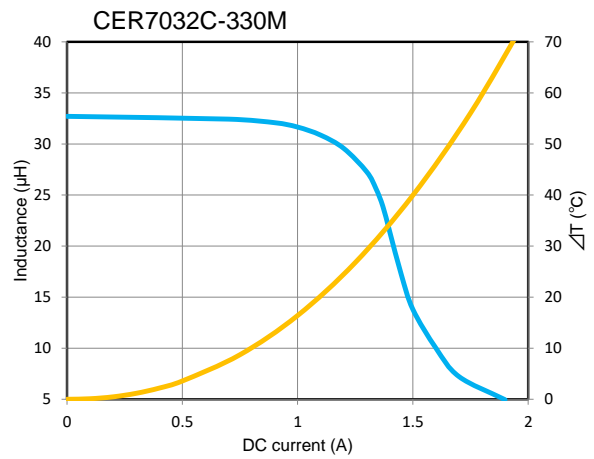
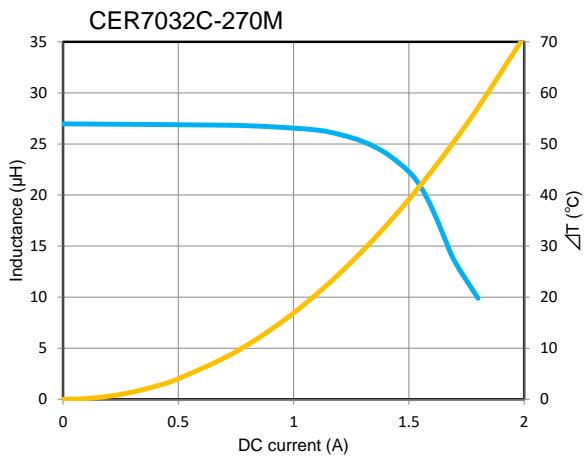
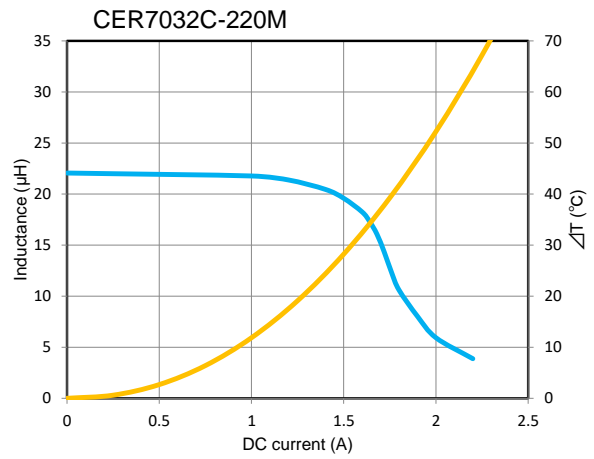
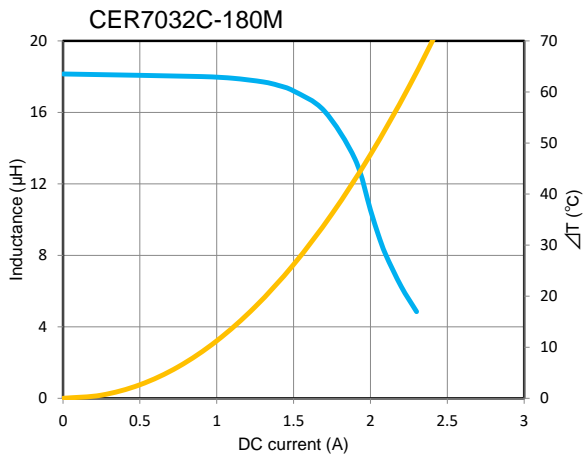
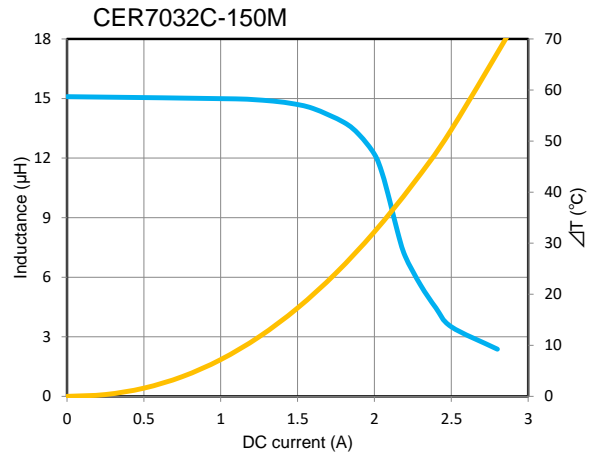
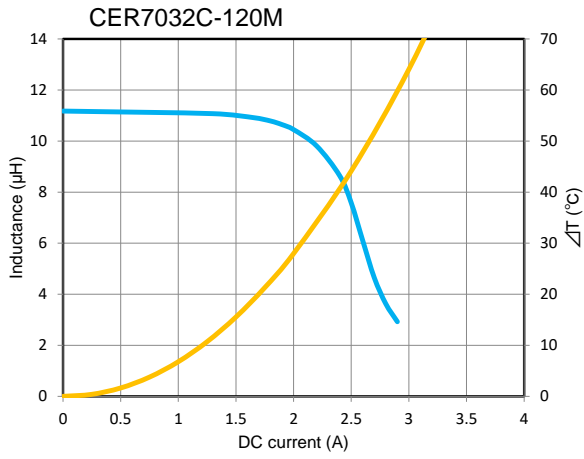

# DC bias characteristics vs Temperature Rise Graph

■ L(25°C)      ■  $\Delta T$

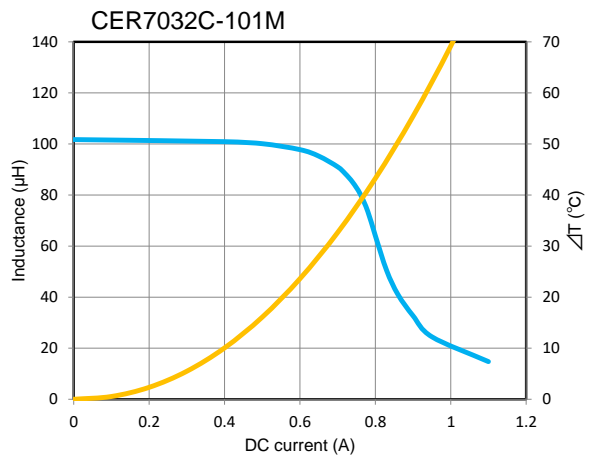
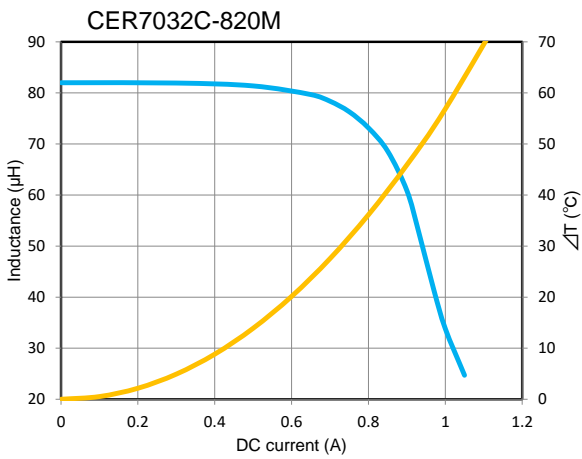
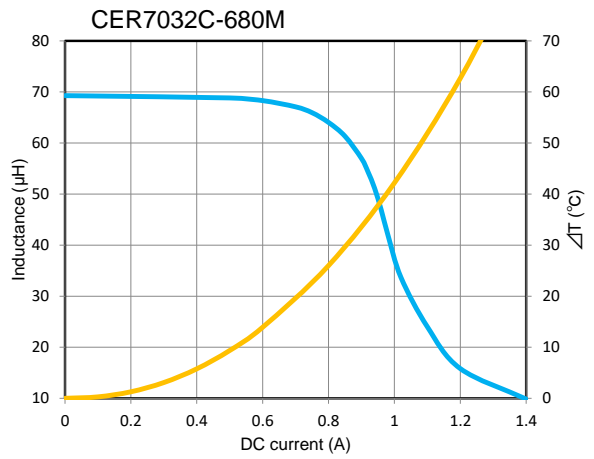
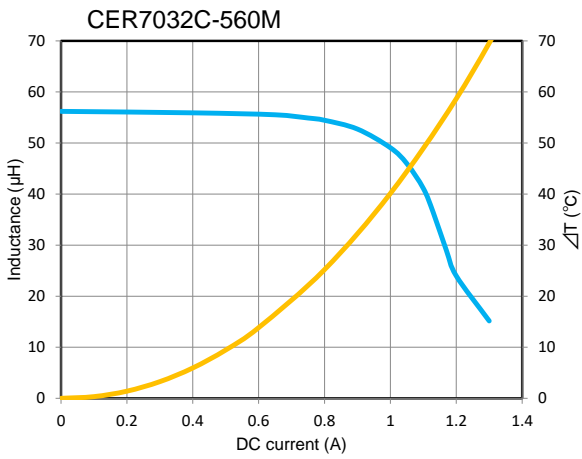
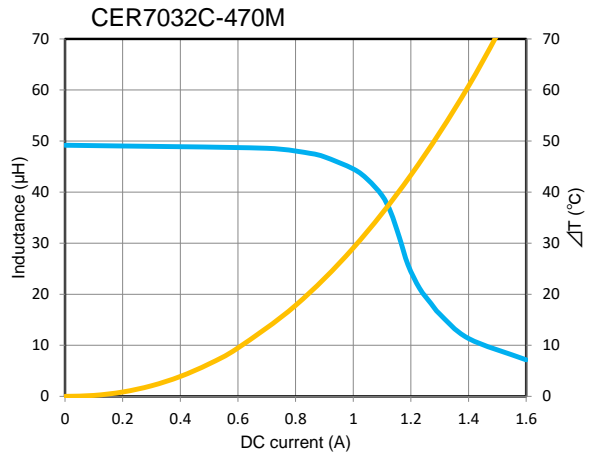
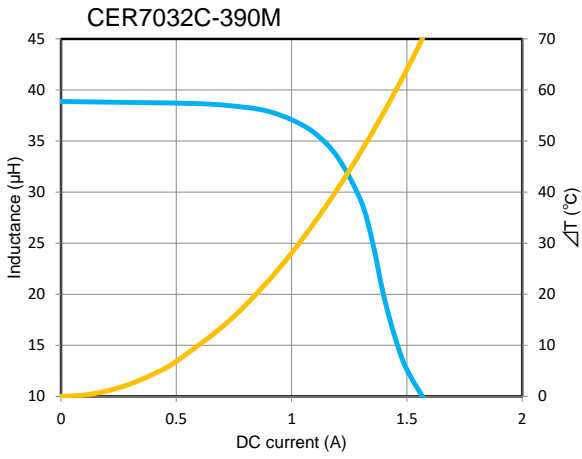

# DC bias characteristics vs Temperature Rise Graph

■ L(25°C)      ■  $\Delta T$

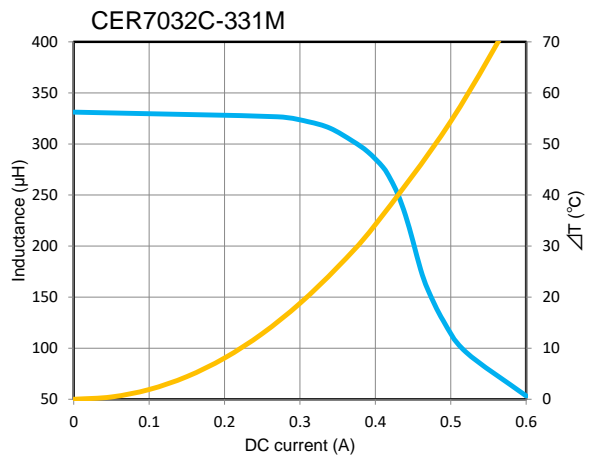
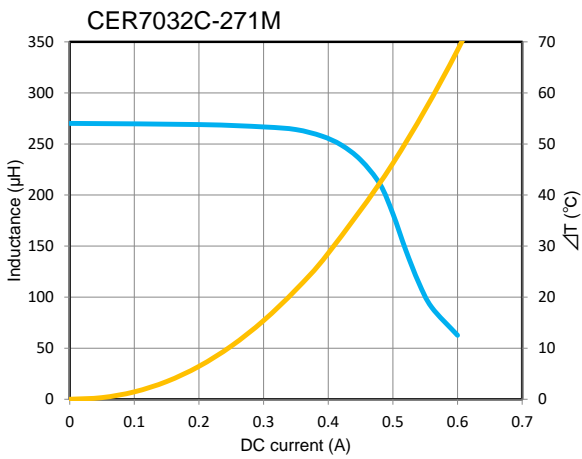
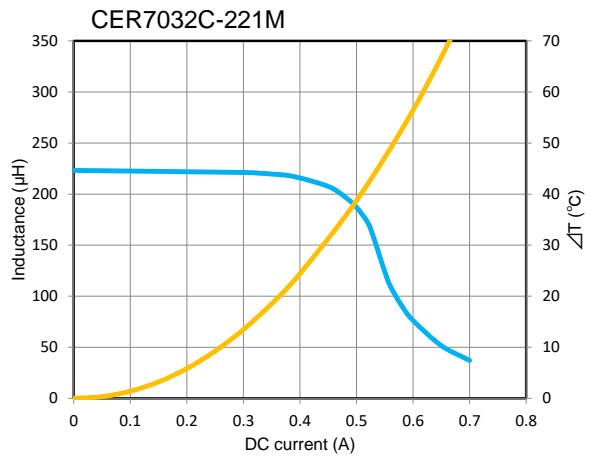
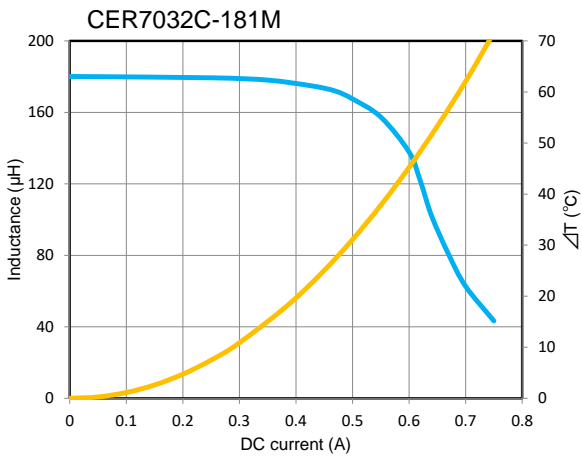
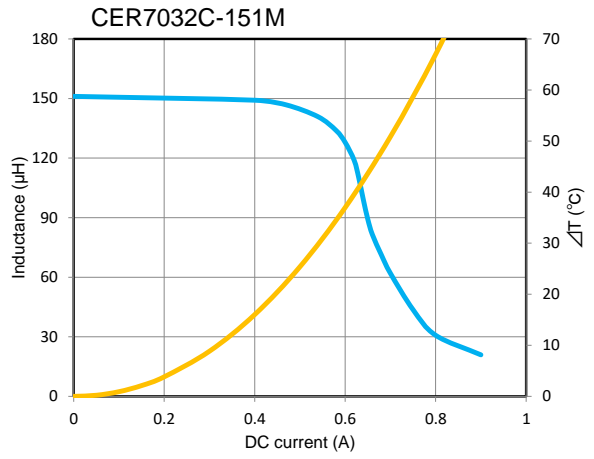
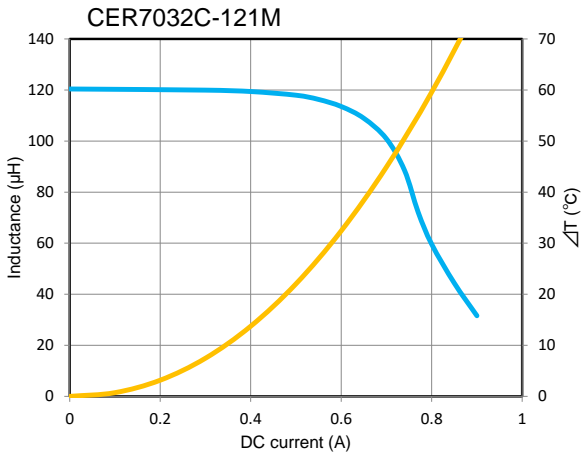

■ L(25°C)

■  $\Delta T$

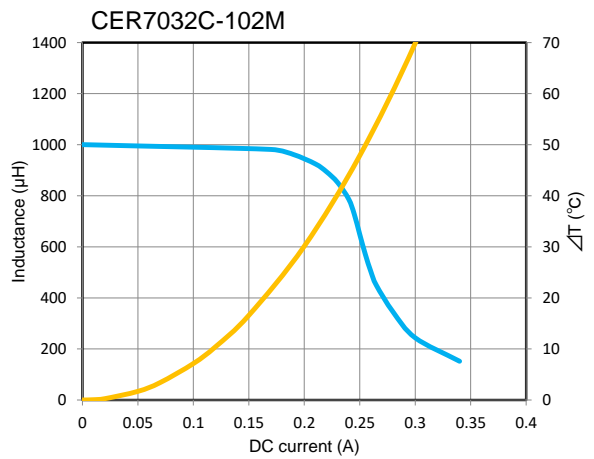
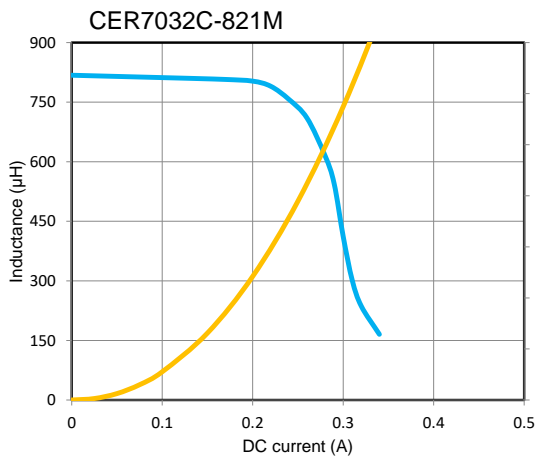
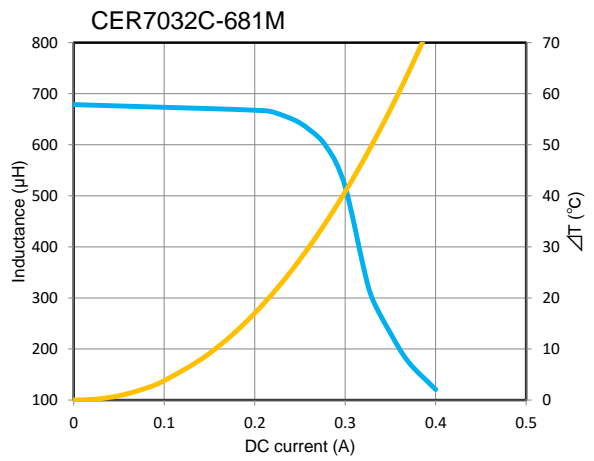
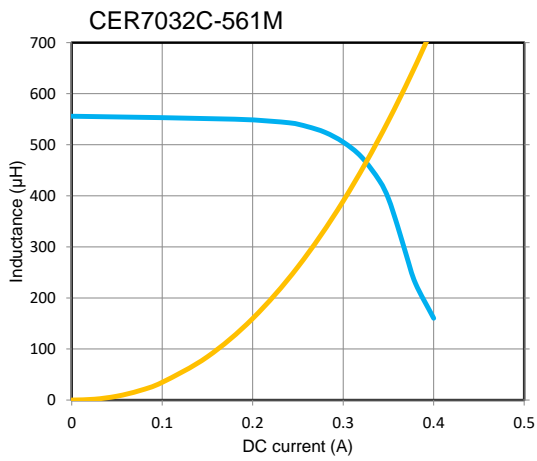
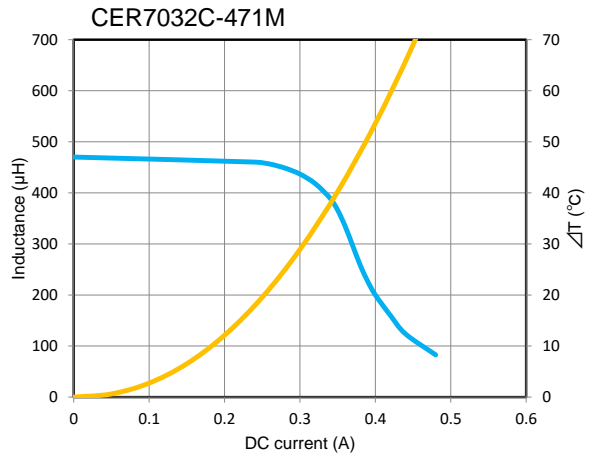
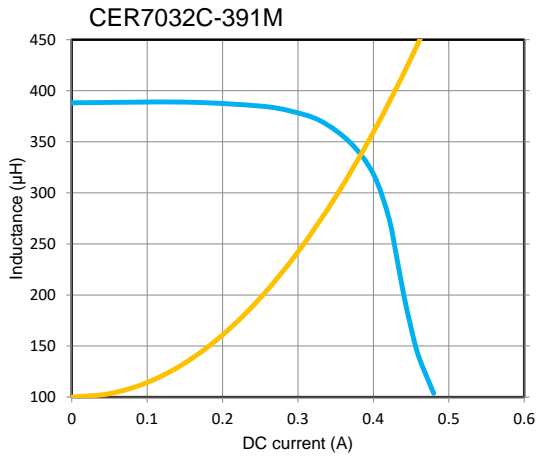

サガミ エレク株式会社  
SAGAMI ELEC CO., LTD.