

## 開磁路構造

Magnetically Unshielded Structure

面実装パワーインダクタ

SMD Fixed Power Inductors

# CJD series

RoHS

AEC-Q200

CJD6045

CJD6057

CJD8050

### 特徴

- ・ 開磁路構造の電源用パワーインダクタ
- ・ サイズ：5.8mm角、7.8mm角
- ・ 高さ：4.5mm、5.0mm、5.7mm
- ・ mHオーダーの仕様にも対応（CJD6057は最大33mHまで対応）
- ・ 大電流対応
- ・ 電極付きコアの採用により耐たわみ、耐衝撃性に優れた構造
- ・ 動作温度範囲：-40°C～+125°C（自己発熱を含む）

### Features

- ・ Power Inductor for Power Supply with Magnetically Unshielded Structure
- ・ Size:5.8mm square and 7.8mm square
- ・ Height:4.5mm、5.0mm、5.7mm
- ・ A Specification for order by mH available(CJD6057 is available up to 33mH)
- ・ Support High-currents
- ・ Excellent in deflecting resistance and impact resistance by employing cores with electrode
- ・ Operating Temperature :-40°C～+125°C(Including Self-heating)



\* 記載内容は、予告無く変更あるいは製造中止する場合があります。ご注文時は最新の情報をご確認願います。

\* Any products mentioned in this catalog are subject to any modification or termination without prior notice. Please check a latest information at placing a purchase order.

\* 記載製品のご使用に際しては、カタログ記載の『ご注意』をご確認願います。

\* Please refer to " DIRECTIONS " in the catalog for proper use of the products.

## ■ CJD6045

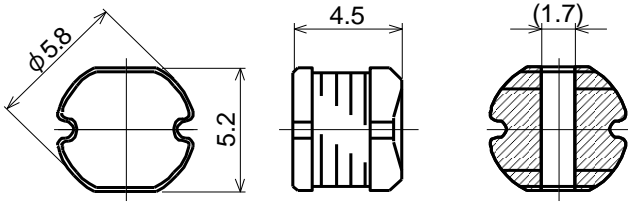

## ■ CJD6057

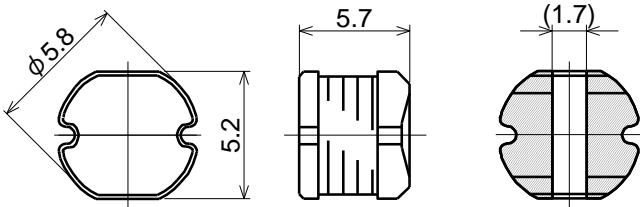

## ■ CJD8050

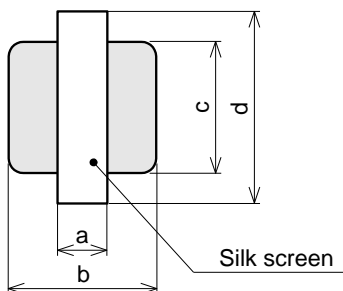
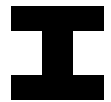
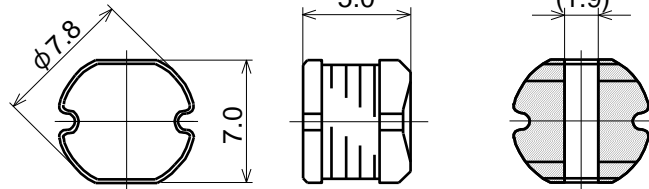

Recommended Land Pattern 推奨ランドパターン

Type	a	b	c	d
CJD6045	1.7	6.0	5.5	7.0
CJD6057	1.7	6.0	5.5	7.0
CJD8050	1.9	8.7	7.3	9.0



\* 記載内容は、予告無く変更あるいは製造中止する場合があります。ご注文時は最新の情報をご確認願います。  
 \* Any products mentioned in this catalog are subject to any modification or termination without prior notice. Please check a latest information at placing a purchase order.  
 \* 記載製品のご使用に際しては、カタログ記載の『ご注意』をご確認願います。  
 \* Please refer to " DIRECTIONS " in the catalog for proper use of the products.

# Power Inductors for Surface Mounting



## ■ CJD6045 / CJD6057 / CJD8050

Inductance  
インダクタンス

DC Resistance  
直流抵抗 (mΩ)  
max. - typical

DC saturation allowable current  
直流重畳許容電流 (A)

Temperature rise allowable current  
温度上昇許容電流 (A)

Code	(μH)	CJD6045		CJD6057		CJD8050		CJD6045	CJD6057	CJD8050	CJD6045	CJD6057	CJD8050
1R2	1.2	0.017	0.013					4.50			3.900		
1R3	1.3					0.011	0.009			7.700			4.900
1R6	1.6	0.019	0.015					4.00			3.500		
1R8	1.8					0.013	0.010			6.300			4.500
2R0	2.0	0.022	0.017					3.70			3.100		
2R4	2.4					0.016	0.012			5.90			4.15
2R7	2.7	0.025	0.020					3.30			2.90		
3R0	3.0	0.028	0.021			0.018	0.014	3.00		4.90	2.80		3.90
3R6	3.6	0.031	0.024			0.020	0.015	2.70		4.20	2.60		3.75
4R3	4.3	0.035	0.027			0.022	0.017	2.50		4.00	2.50		3.60
5R1	5.1	0.038	0.029			0.025	0.019	2.35		3.60	2.45		3.45
5R6	5.6	0.042	0.032					2.25			2.40		
6R2	6.2	0.046	0.035			0.027	0.021	2.05		3.40	2.30		3.30
7R5	7.5	0.048	0.037			0.032	0.024	1.95		3.15	2.20		3.10
8R2	8.2	0.057	0.044			0.035	0.027	1.90		3.00	2.00		3.00
9R1	9.1	0.060	0.047					1.75			1.95		
100	10	0.071	0.055			0.044	0.034	1.65		2.70	1.75		2.70
120	12	0.076	0.058			0.052	0.040	1.60		2.40	1.70		2.50
150	15	0.092	0.071			0.065	0.050	1.30		2.10	1.55		2.20
180	18	0.11	0.085			0.084	0.064	1.25		1.95	1.45		2.00
220	22	0.13	0.10			0.094	0.072	1.10		1.75	1.30		1.85
270	27	0.17	0.13			0.12	0.091	1.00		1.60	1.15		1.65
330	33	0.21	0.16			0.15	0.111	0.95		1.45	1.05		1.45
390	39	0.25	0.19			0.17	0.127	0.86		1.30	0.97		1.35
470	47	0.28	0.21			0.19	0.147	0.75		1.25	0.90		1.30
560	56	0.34	0.26			0.23	0.173	0.70		1.20	0.80		1.20
680	68	0.40	0.32			0.27	0.208	0.65		1.10	0.70		1.10
820	82	0.50	0.39			0.33	0.249	0.60		1.00	0.65		1.00
101	100	0.60	0.46			0.40	0.305	0.55		0.90	0.60		0.93
121	120	0.72	0.56			0.48	0.369	0.48		0.85	0.55		0.84
151	150	0.85	0.66			0.61	0.470	0.45		0.70	0.50		0.75
181	180	1.05	0.80			0.70	0.532	0.40		0.60	0.45		0.70
221	220	1.25	0.97			0.86	0.660	0.35		0.52	0.40		0.65
271	270	1.65	1.27			1.07	0.817	0.30		0.50	0.35		0.55
331	330	2.05	1.57			1.30	0.993	0.27		0.45	0.32		0.50
391	390	2.3	1.77			1.53	1.175	0.25		0.44	0.30		0.47
471	470	2.7	2.04			1.84	1.413	0.23		0.42	0.29		0.43
561	560	3.2	2.51			2.06	1.58	0.19		0.39	0.27		0.40
681	680	4.3	3.31			2.53	1.95	0.18		0.34	0.22		0.35
821	820	4.9	3.75			3.29	2.53	0.17		0.32	0.21		0.33
102	1000	5.6	4.32	3.7	2.82	3.90	3.00	0.14	0.128	0.29	0.20	0.253	0.30
122	1200	6.3	4.89	4.1	3.17	4.86	3.73	0.13	0.119	0.26	0.19	0.239	0.27
152	1500	8.6	6.57	5.4	4.16	6.39	4.91	0.12	0.106	0.23	0.16	0.209	0.23
182	1800	10.0	7.68	7.0	5.45	7.07	5.43	0.115	0.101	0.21	0.16	0.180	0.21
222	2200	11.2	8.62	8.0	6.27	9.25	7.10	0.110	0.093	0.19	0.15	0.167	0.19
272	2700	15.6	12.0	9.3	7.16	10.7	8.20	0.100	0.081	0.17	0.13	0.150	0.17
332	3300	16.8	12.8	12.2	9.41	14.0	10.79	0.085	0.074	0.15	0.12	0.135	0.15
392	3900			15.7	12.2	15.8	12.12		0.066	0.13		0.117	0.14
472	4700			17.9	13.9	20.5	15.71		0.061	0.12		0.108	0.13
562	5600			20.1	15.5	23.2	17.79		0.055	0.11		0.104	0.12
682	6800			27.0	21.0	26.2	20.10		0.048	0.10		0.089	0.11
822	8200			30.6	24.0				0.047			0.088	
103	10000			43.0	33.6				0.042			0.069	
123	12000			48.8	38.1				0.038			0.065	
153	15000			56.7	44.2				0.033			0.062	
183	18000			64.5	50.2				0.031			0.055	
223	22000			96.5	77.6				0.028			0.044	
273	27000			112	89.5				0.025			0.041	
333	33000			129	105				0.022			0.037	

Notes: 1. Measurement Frequency for Inductance: 1kHz  
 2. DC saturation allowable current: Value of inductance decrease within 10%  
 3. Temperature rise allowable current: A rise in temperature of core surface is within 40°C

記事: 1. インダクタンス測定周波数: 1kHz  
 2. 直流重畳許容電流: インダクタンスの減少が10%以内の電流値  
 3. 温度上昇許容電流: コアの表面温度上昇が40°C以下の電流値

### Inductance Range インダクタンス範囲

Tolerance	CJD6045	CJD6057	CJD8050
±20% (M)	1.2 ~ 9.1μH	----	1.3 ~ 8.2μH
±15% (L)	10 ~ 18μH	----	----
±10% (K)	22 ~ 3300μH	1 ~ 33mH	10 ~ 6800μH

### Parts Code 品番コード例

CJD6045	—	100	K
Type	Inductance Code	Tolerance	
タイプ	インダクタンスコード	許容差	



\* 記載内容は、予告無く変更あるいは製造中止する場合があります。ご注文時は最新の情報をご確認願います。  
 \* Any products mentioned in this catalog are subject to any modification or termination without prior notice. Please check a latest information at placing a purchase order.  
 \* 記載製品のご使用に際しては、カタログ記載の『ご注意』をご確認願います。  
 \* Please refer to "DIRECTIONS" in the catalog for proper use of the products.

## ■ CJD6045 / CJD6057 / CJD8050

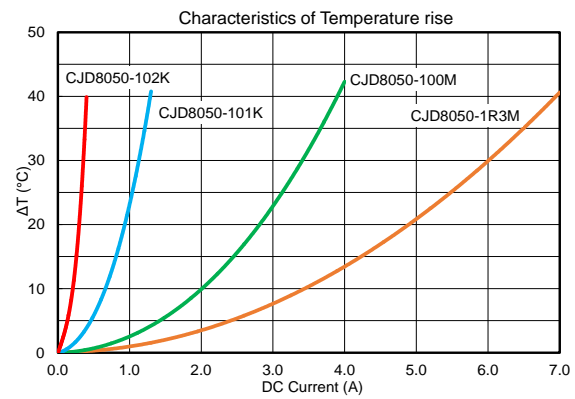
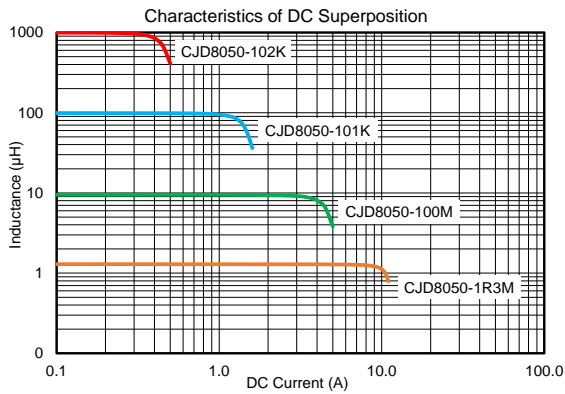
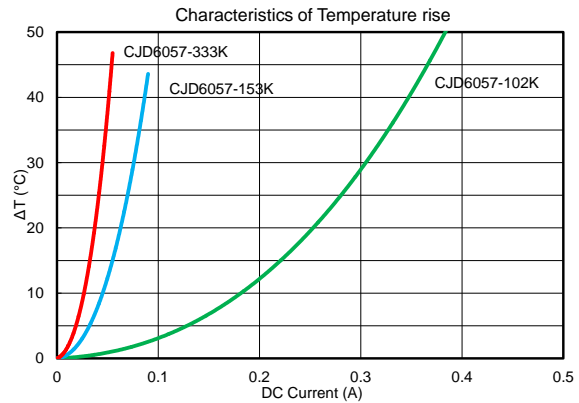
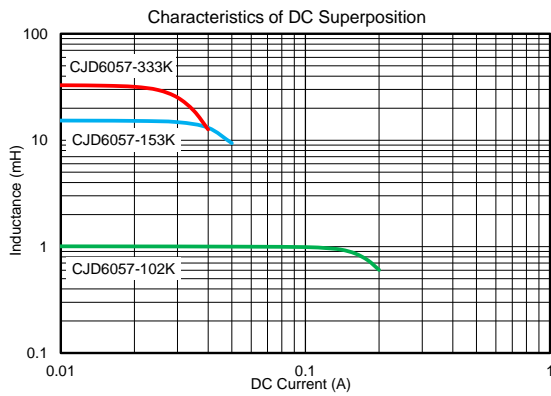
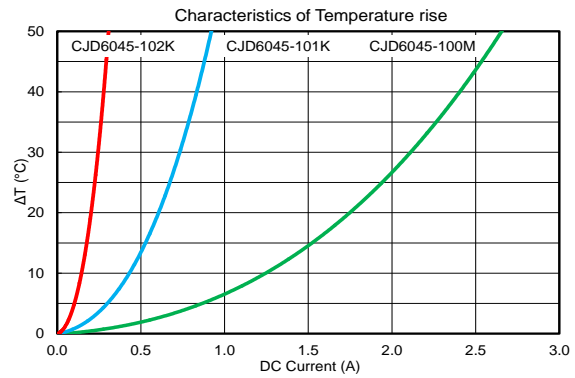
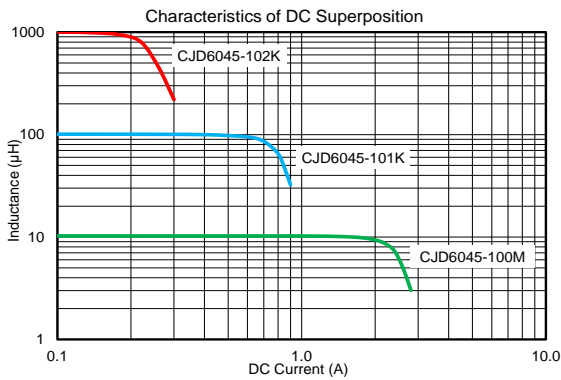

Notes: Graphs are based on typical values of each type, not specific values.

記事: 特性グラフは各タイプの代表値を基に作成しています。規格値ではありません。



\* 記載内容は、予告無く変更あるいは製造中止する場合があります。ご注文時は最新の情報をご確認願います。  
 \* Any products mentioned in this catalog are subject to any modification or termination without prior notice. Please check a latest information at placing a purchase order.  
 \* 記載製品のご使用に際しては、カタログ記載の『ご注意』をご確認願います。  
 \* Please refer to " DIRECTIONS " in the catalog for proper use of the products.